



SIMPLE DOOR
created by
EURO DOOR Sp. z o.o.

www.simpledoor.pl



SIMPLE DOOR
www.simpledoor.pl



It's a simple choice!



10 - 11

12-13

14

15



16 - 17

18 - 21

22

23



24-27

28

29

30-31



32-33

34 - 35

36

37



SIMPLE DOOR

www.simpledoor.pl



Drzwi bezprzylgowe
/ Non-rebated doors
/ Türen ohne Falz



Zawiasy niewidoczne
/ Concealed hinges
/ Unsichtbare Scharniere



Zamek magnetyczny
/ Magnetic lock
/ Magnetschloss



Nietypowe wymiary
/ Custom dimensions
/ Sondergrößen



Fornir naturalny
/ Natural veneer
/ Naturfurnier



Indywidualne barwienia drewna
/ Individual wood dyes
/ Individuelle Holzfarbe



Popularne kolory lakierów RAL
/ Popular RAL colours
/ Beliebte RAL-Farben



Szczotkowanie drewna 3D
/ Wood brushing
/ Holz gebürstet



Drzwi odwrotne (rewersyjne)
/ Reverse door
/ Rücktür



Drzwi przesuwne
/ Sliding door
/ Schiebetür

























Niewidoczne futryny
/ Concealed frames
/ Unsichtbarer Rahmen



Ukryte w ścianach
/ Concealed inside a wall
/ Verdeckt in der Wand



 GR. 1 Dąb standard / Oak standard / Eiche standard	 GR.1 Dąb matowy / Oak matt / Eiche matt.	 GR.1 Koto / Koto wood / Koto	 GR.1 Brzoza fińska / Finnish birch / Birke finnische
 GR. 2 Dąb select prosty / Oak select straight / Eiche select gerade	 GR.2 Orzech amerykański / American walnut / Nuss amerikanisch	 GR.2 Mahoń sapelli pasiak / Sapelli mahog. striped / Sapelli mahog. gestreift	 GR.2 Mahoń sapelli flader / Sapelli mahogany flader / Sapelli mahagoni flader
 GR. 3 RAL 9003 (biały standard) / (white stand.) / (weiß stand.)	 GR.3 RAL 9001	 GR.3 RAL 9002	 GR.3 RAL 9010
 GR.3 RAL 9016	 GR.3 RAL 9018	 GR.3 RAL 7038	 GR.3 RAL 7040
 GR.3 RAL 7042	 GR.3 RAL 7044	 GR.3 RAL 7045	 GR.3 RAL 7047
 GR. EX Dąb sękaty standard / Knotted oak stand. / Asteiche stand.	 GR. EX Orzech canaletto modyfikowany / Canaletto walnut mod. / Nuss canaletto mod.	 GR. EX Dąb bielony modyfikowany / Oak white mod. / Eiche Weiß mod.	 Fornir naturalny / Natural veneer / Natur furnier
			 Kolor RAL - lakier / RAL colour - varnish / RAL-Farbe - lack

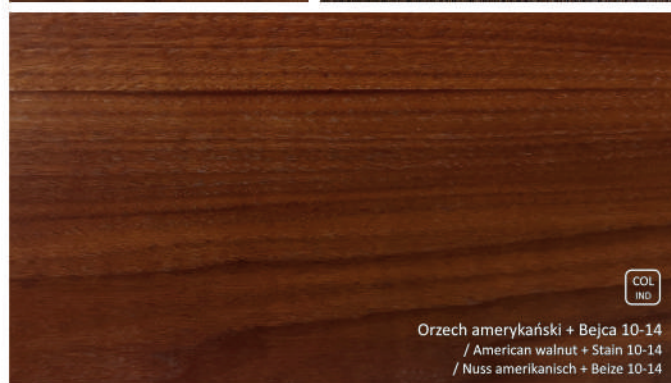
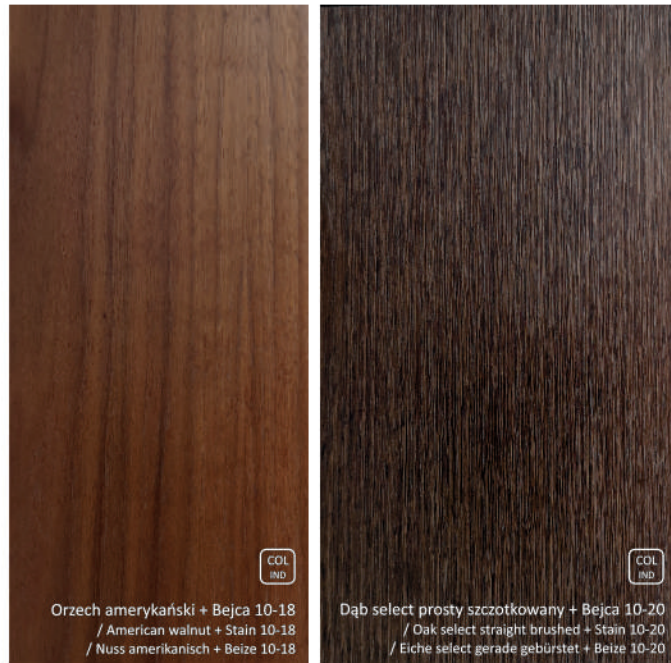

Drewno jest produktem naturalnym i posiada różnice w strukturze i kolorze. Wszystkie próbki kolorystyczne mogą się także różnić ze względu na różnice w szlifowaniu, aplikacji bejcy i/lub materiale używanym do lakierowania. Niemniej nie jest to podstawą do reklamacji. Możliwe jest - wykonanie próbki kolorystycznej dla każdego zamówienia.

Wood is a natural product and shows variation in structure and colour. All colour samples may also differ on account of differences in grinding, stain application and/or varnishing material used. Nevertheless, this is not the basis for a complaint. Colour samples can be prepared for each order.

Holz ist ein Naturprodukt und hat Variation in Struktur und Farbe. Alle Farbmuster kann auch auf Grund von Unterschieden in Schliff, Beizauftrag und/oder eingesetztem Lackmaterial zu abweichenden Resultaten führen. Dennoch ist dies nicht der Grund, sich zu beschweren. Es ist möglich - Farbmuster für jede Bestellung zu machen.



Indywidualne barwienia drewna
/ Individual wood dyes
/ Individuelle Holzfarbe





Szczotkowanie drewna
/ Wood brushing
/ Holz gebürstet





SIMPLE DOOR
www.simpledoor.pl



FLAT V

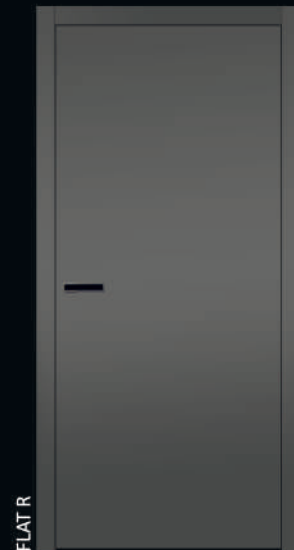

FLAT R

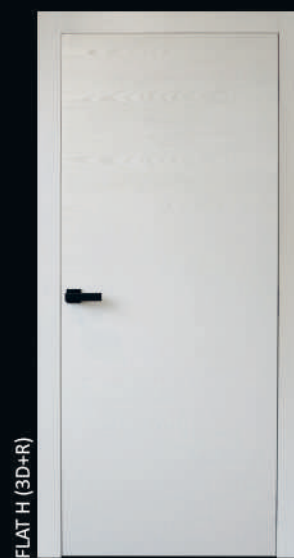

FLAT H (3D+R)

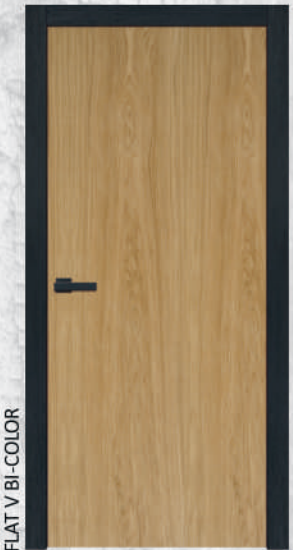

FLAT V BI-COLOR

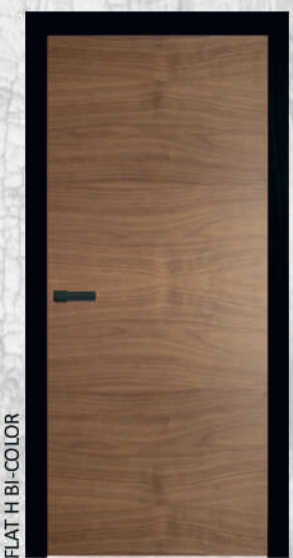

FLAT H BI-COLOR

FLAT

FLAT: V - VERT.; H - HORIZ.; R - RAL;
BI-COLOR: (Skrz.+Osc./Wing+Fr./Flügel.+Ra.)
V+R, V+STD, H+R, H+STD, R+R, R+STD



CROSS



CROSS H4

Dąb standard + Bejca
/ Oak stand. + stain / Eiche stand. + Beize

Simple Door

www.simpledoor.pl



CROSS V15 / LINK V15



CROSS V25 / LINK V25



CROSS H2



CROSS X1

CROSS V15: H- 15V/XH cm; CROSS V25: H- 25V/XH cm; CROSS H2: V- 30H/XV/30H cm; CROSS H4: 5x X/4; CROSS X1: V- 5x X/5, H- 2x X/2; LINK V15: H- 15V/X-R cm; LINK V25: H- 25V/X-R cm;



LINK



LINK V15

INOX



INOX H1

Simple Door

www.simpledoor.pl



INOX V1



INOX V1 MIX



INOX H2



INOX H4



INOX (INS INOX 1 CM); WER: INOX H1: V- X/1/110 cm;
INOX V1: H- 15/1/X cm; INOX V1 MIX: H- 15V/1/XH cm;
INOX H2: V-30/1/X/1/30 cm; INOX H4: 5 x X/5 (4 x INS)

Dąb standard + Bejca biała 2
/ Oak stand. + white stain 1 / Eiche stand. + Beize weiß 2

Simple Door

www.simpledoor.pl



ROUND H1

ROUND



ROUND H2



ROUND H2 DPX



ROUND H4 DUAL



ROUND H4 ASX



Dąb sękaty szczotkowany + Bejca 10-18
/ Knotted oak brushed + stain 10-18 / Asteiche gebürstet + Beize 10-18

ROUND (INS 1 CM RD); WER: H1: V-X/1/110 cm, H-25/X cm;
H2: V-30/1/X/1/30 cm, H-25/X cm; H2 DPX: V-30/1/X/1/30 cm,
H-15/10/X cm; H4 DUAL: V-30/1/10/1/X/1/10/1/30 cm,
H-(1,3) 25/X, (2,4) X/25 cm; H4 ASX: V-30/1/30/1/X/1/30/1/30 cm,
H-(1,4) 25/X, (2,3) X/15 cm

LINEAR

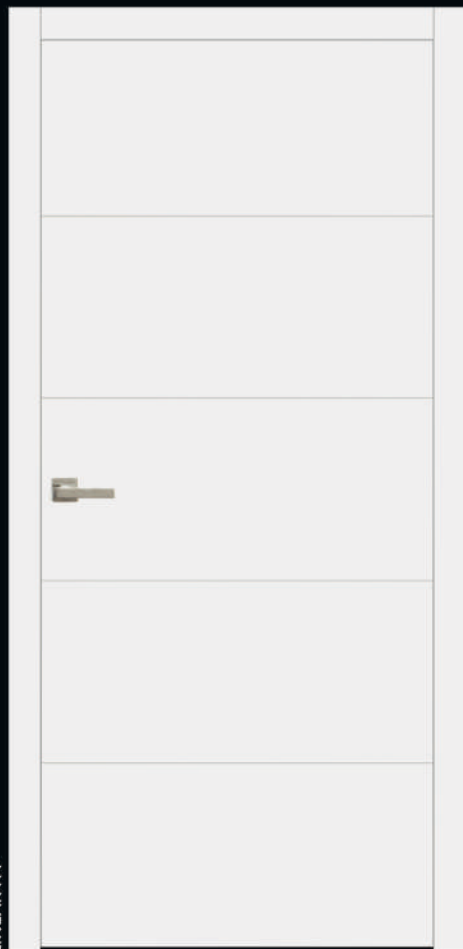

LINEAR H4

SIMPLE DOOR

www.simpledoor.pl

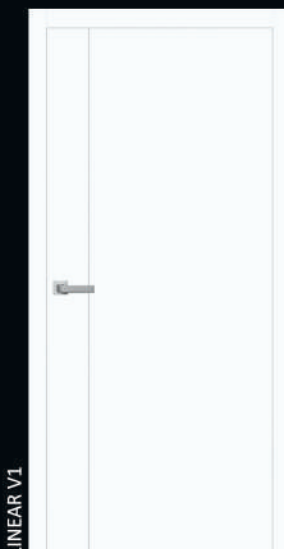

LINEAR V1

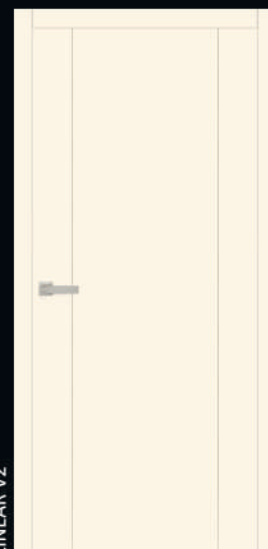

LINEAR V2

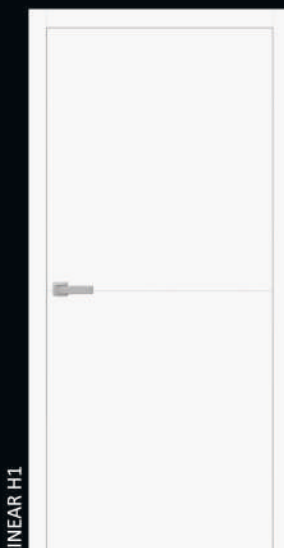

LINEAR H1

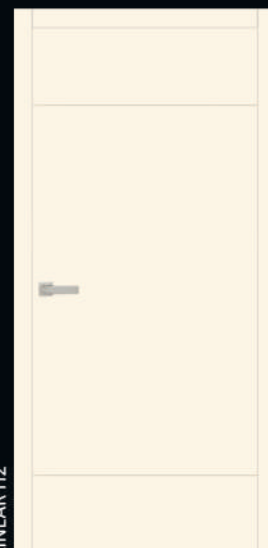

LINEAR H2



LINEAR (L,U*LN - ~4 x 1,5 mm); WER.: H4: V- 5x X/5 (4 x „U”LN); V1: H- 15/X cm; V2: H- 15/X/15 cm; H1: V- X/110 cm; H2: V- 30/X/30 cm; RUSTIC („Q”LN - ~5 x 3mm); H- 5x X/5 (4 x „Q”LN)



RUSTIC



RUSTIC

FUSION



FUSION A-H

Simple Door

www.simpledoor.pl



FUSION A-R



FUSION A-V (BI-COLOR)



FUSION S-R

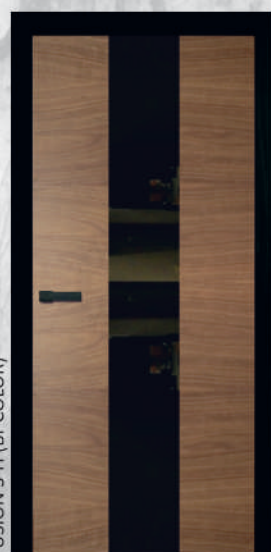

FUSION S-H (BI-COLOR)



FUSION (INS GLASS - BLACK & WHITE LACOBEL);
 WER: A-V, A-H, A-R: H- 15/25/X cm; S-V, S-H, S-R:
 H- X/25/X cm; FUSION SLIM V, H, R: H- 15/8/X cm



Simple Door

www.simpledoor.pl



FUSION SLIM-V



FUSION SLIM-R



FUSION SLIM-H



FUSION SLIM-V (BI-COLOR)



FUSION XXL-H (3D BI-COLOR)



FUSION (INS GL - BLACK & WHITE LACOBEL);
WER: FUSION XXL V, H, R: H- 15/X/15 cm

SIMPLE DOOR
www.simpledoor.pl



FUSION XXL-V



MAXIMAL



MAXIMAL

Simple Door
www.simpledoor.pl



MAXIMAL FR

Dąb standard matowy
/ Oak standard matt / Eiche standard matt



Simple Door
www.simpledoor.pl



MAXIMAL FV



MAXIMAL SLIM



MAXIMAL FH



CENTRAL 15

MAXIMAL: H- 15/X/15 cm, GL; MAXIMAL F: N/GL (FV- VERT, FH- HORIZ., FR- RAL); MAXIMAL SLIM: H- 12/X/12 cm, GL; MAXIMAL SLIM F: N/GL (FV- VERT, FH- HORIZ., FR - RAL);



CENTRAL



CENTRAL 8

CENTRAL 8: H- X/8/X cm, GL; CENTRAL 15: H- X/15/X cm, GL; CENTRAL 25: H- X/25/X cm, GL; CENTRAL F: N/GL (FV - VERT., FH - HORIZ., FR - RAL)

MINIMAL



MINIMAL 8

SIMPLE DOOR
www.simpledoor.pl



MINIMAL SLIM 3 MIX

SIMPLE DOOR
www.simpledoor.pl



MINIMAL 8



MINIMAL 15



MINIMAL 25



MINIMAL SLIM 3



MINIMAL SLIM 12



MINIMAL 8 BI-COLOR



MINIMAL 8 MIX

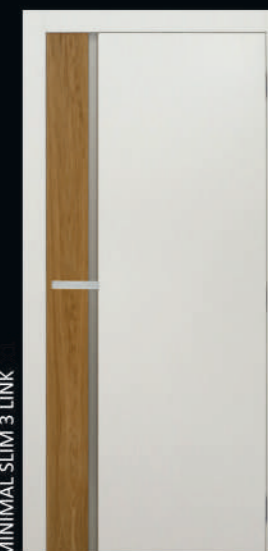

MINIMAL SLIM 3 LINK

MINIMAL 8: H-15/8/X cm, GL; MINIMAL 15: H-15/15/X cm, GL; MINIMAL 25: H-15/25/X cm, GL;
MINIMAL F: N/GL (FV- VERT., FH- HORIZ., FR- RAL, MIX-15V+XH); MINIMAL SLIM 3: H-12/3/X cm, GL;
MINIMAL SLIM 12: H-12/12/X cm, GL; SLIM F: N/GL (FV- VERT., FH- HORIZ., FR- RAL, MIX-12V+XH)

Orzech amerykański
/ American walnut / Nuss amerikanisch



INVERSE



INVERSE XXL

SIMPLE DOOR

www.simpledoor.pl



INVERSE 25 MIX

26 Dąb standard szcztokowany + Bejca MIX-ED 1
/ Oak standard brushed + MIX-ED 1 stain / Eiche standard gebürstet + MIX-ED 1 Beize



INVERSE 15: H-X/15/15 cm, GL; INVERSE 25: H-X/25/15 cm,
GL; INVERSE XXL: H-25/X/15 cm, GL; INVERSE F: N/GL
(FV-VERT., FH-HORIZ., FR-RAL)



DUAL



DUAL

Simple Door

www.simpledoor.pl



DUAL SLIM

Simple Door

www.simpledoor.pl



LIMIT V1

LIMIT



LIMIT V1



LIMIT V2



LIMIT V3



LIMIT H

Dąb sękaty szczotkowany + Bejca brunat 112
/ Knotted oak brushed + stain Brown 112 / Asteiche gebürstet + Beize Braun 112



DUAL: H-15/8/X/8/15 cm, GL;
DUAL SLIM: H-12/3/X/3/15 cm, GL

Dąb standard szczotkowany + Lakier (biały)
/ Oak stand. brushed + Varnish (white) / Eiche stand. gebürstet + Lack (weiß)



LIMIT V1: H- 15/8/X cm, V-XGL/100 cm; LIMIT V2:
H- 15/8/X cm, V-X/100GL cm; LIMIT V3: H- X/8/X cm,
V-30/XGL cm; LIMIT H: H- 15/X cm, V- X/8/X cm;



CLASSIC



CLASSIC FR



CLASSIC FH



CLASSIC FV



CLASSIC SLIM



CLASSIC SLIM FH

CLASSIC



Dąb standard + Bejca (czerni)
/ Oak stand. + Stain (black) / Eiche stand. + Beize (schwarz)



CLASSIC: H-15/X/15 cm, V-15/X/15 cm, GL; CLASSIC F: N/GL
(FV-VERT., FH-HORIZ., FR-RAL); CLASSIC SLIM: H-12/X/12 cm,
V-12/X/12 cm, GL; CLASSIC SLIM F: N/GL (FH v FV v FR);

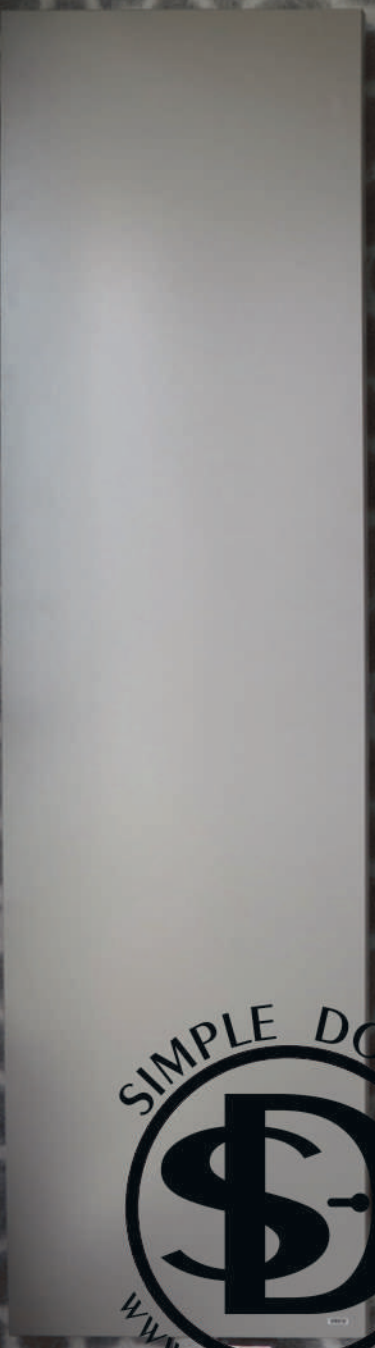

NEW CLASSIC GLASS

NEW CLASSIC

NEW CLASSIC (F): H-14/X/14 cm, V-14/X/18 cm, N/GL;
NEW CLASSIC GLASS: H-14/X/14 cm, V-14/X/18 cm, GL;



Dąb sekaty standard
/ Knotted oak stand. / Asteiche stand.

MODIFIC



MODIFIC REGULAR S5P6

SIMPLE DOOR
www.simpledoor.pl



MODIFIC REGULAR S6P5

Dąb standard + Bejca
/ Oak stand. + Stain / Eiche stand. + Beize



SIMPLE DOOR
www.simpledoor.pl

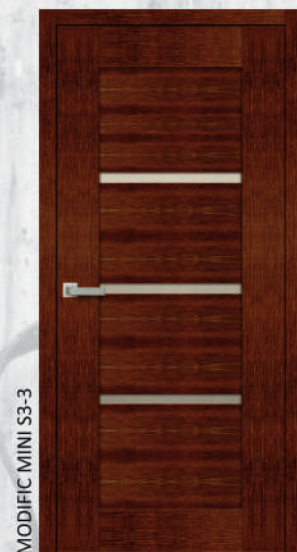

MODIFIC MINI S3-3



MODIFIC MINI S4-3



MODIFIC MINI S3-15



MODIFIC MINI S1-8



MODIFIC MAXI P3-4



MODIFIC MAXI P4-4



MODIFIC MAXI P3-15



MODIFIC MAXI P1-8

MODIFIC: H-15/X/15 cm, V-15/X*/15 cm; WER: REGULAR S5P6: X*- X/11 x 5GL; REGULAR S6P5: X*- X/11 x 6GL;
MINI S3-3: X*- 3x3 cm GL; MINI S4-3: X*- 4x3 cm GL; MINI S3-15: X*- 3x15 cm GL; MINI S1-8: X*- 1x8 cm GL;
MAXI P3-4: X*- 3x4 cm; MAXI P4-4: X*- 4x4 cm; MAXI P3-15: X*- 3x15 cm; MAXI P1-8: X*- 1x8 cm;

LEVEL



LEVEL 2: V-30/8/X/8/30 cm, GL; LEVEL 2 XL: V-30/8/X/8/30 cm, GL; LEVEL 1: V-30/8/X cm, GL; LEVEL 1 XL: V-30/12/X cm, GL;



SIMPLE DOOR
www.simpledoor.pl

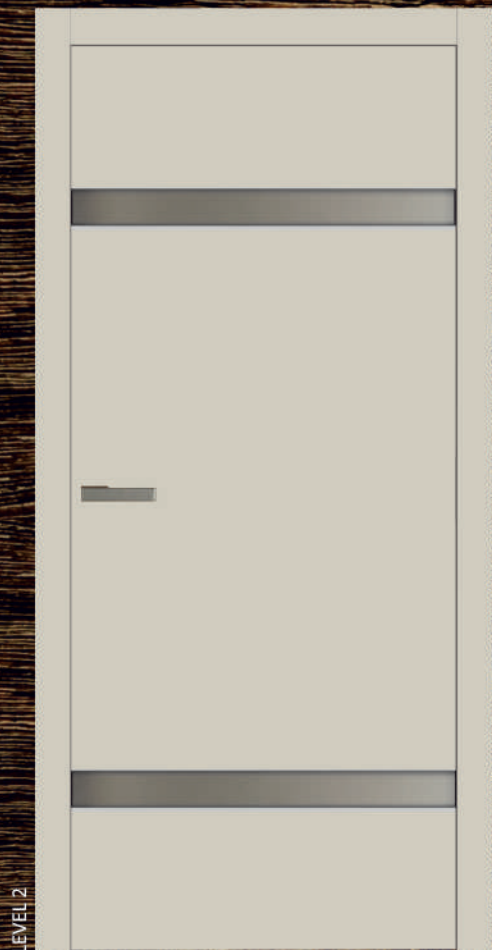

Dąb standard szcztokowany + Bejca (ciemna)
/ Oak stand, brushed + Stain (dark) / Fichte stand, gebürstet + Beize (dunkel)

SIMPLE DOOR
www.simpledoor.pl



Orzech amerykański + Bejca 10-18
/ American walnut + Stain 10-18 / Nuss amerikanisch + Beize 10-18



GLOSSY



GLOSSY 15: H-15/X GL cm; GLOSSY 25: H-25/X GL cm

INVISIBLE PRO

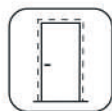

Niewidoczne futryny
/ Concealed frames
/ Unsichtbarer Rahmen

ALU

Z futrynami aluminiowymi
/ with aluminium frames
/ mit Alu Rahmen

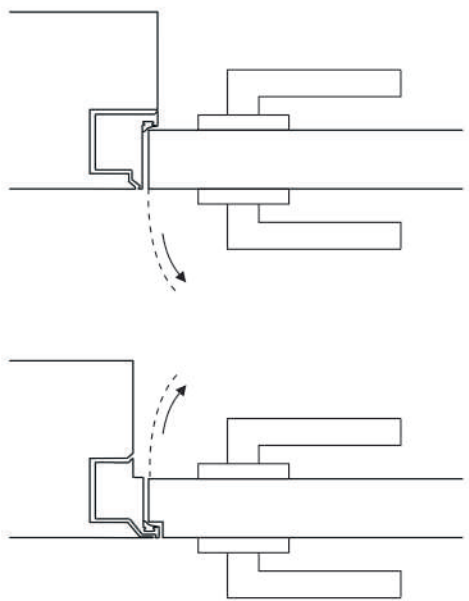



SIMPLE DOOR

www.simpledoor.pl

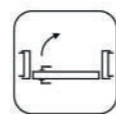

Drzwi odwrotne
(rewersyjne)
/ Reverse door
/ Rücktüren

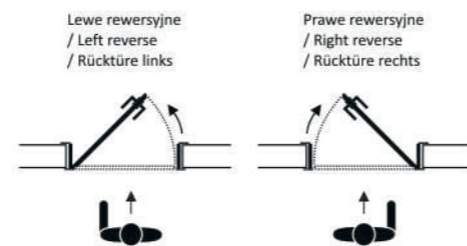
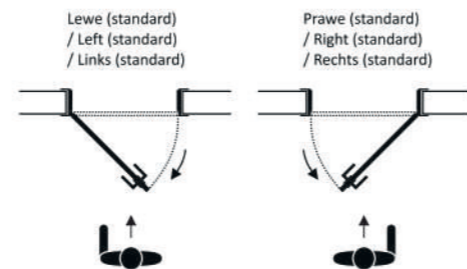

konieczne / necessary / erforderlich :



Zawiasy niewidoczne
/ Concealed hinges
/ Unsichtbare Scharniere



Zamek magnetyczny
/ Magnetic lock
/ Magnetschloss



SIMPLE DOOR

www.simpledoor.pl

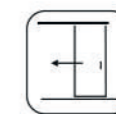

Drzwi przesuwne
/ Sliding door
/ Schiebetür



Z blendami drewnianymi
/ With wooden covers
/ mit Holzblenden



Z blendami aluminiowymi
/ with aluminium covers
/ mit Alublenden

Systemy ścienne bez ościeżnic
/ Wall-fixed systems without frames
/ Wandsysteme ohne Rahmen



Systemy ścienne z ościeżnicami
/ Wall-fixed systems with frames
/ Wandsysteme mit Rahmen



Drzwi przesuwne ukryte w ścianach (kasety ościeżnicowe)
/ Sliding doors hidden in the wall (pocket doors, cassette)
/ Schiebetüren verdeckt in der Wand (Rahmenkassetten)

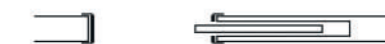

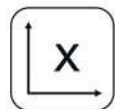

Wymiary standardowe
/ Standard dimensions
/ Standard Größen

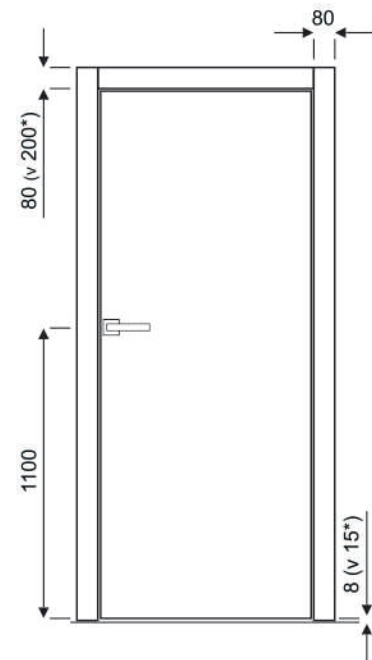

$S_p = \text{„60“}, \text{„70“}, \text{„80“}, \text{„90“}, (\text{„65“}, \text{„75“}, \text{„85“})$

$H_z = 205 (202, 203, 204 \text{ v } 206,5 \text{ cm})$

$G = 8, 9, 10, \dots \text{ cm } (+ 2 \text{ cm REG.})$

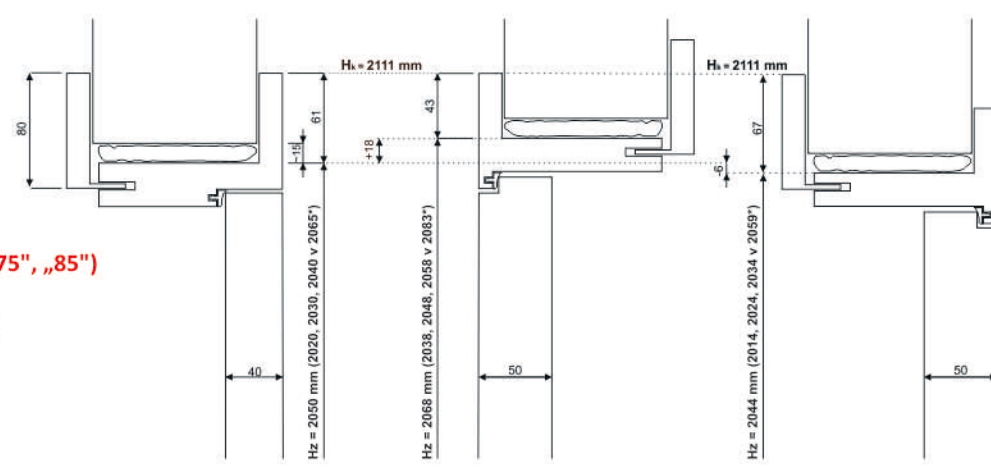
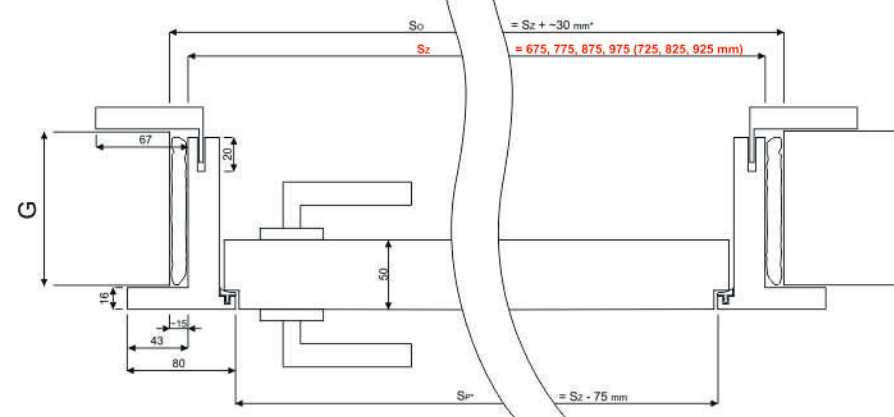
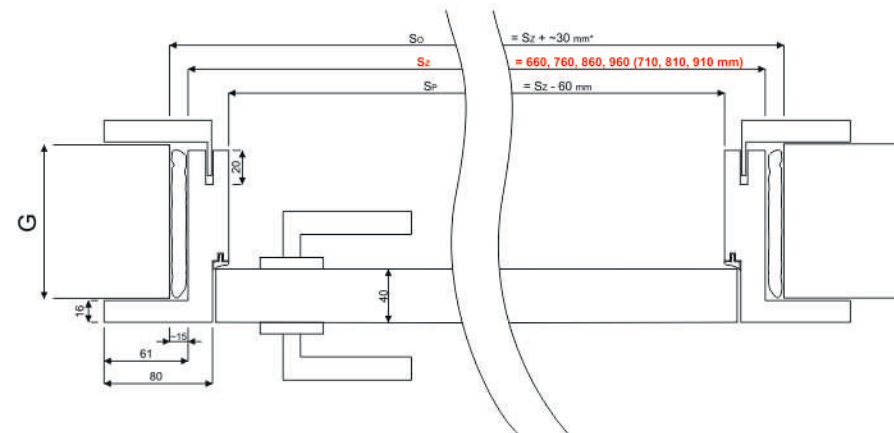

- | | |
|--|--|
| V (VERT.) - pionowy / vertical / vertikal | INS - wklejka / inset / Einsatz |
| H (HORIZ.) - poziomy / horizontal / horizontal | LN - linia / line / Linie |
| R (RAL) - lakierowany / varnished / lackiert | GL - szkło / glass / Glas |
| STD (stand.) - standard / standard / standard | N/GL - bez szkła / without glass / ohne Glas |
| WER - wersja / version / Version | RD - zaokrąglony / rounded / rundlich |

Uwaga: Wszystkie informacje bez gwarancji. Ilustracje mogą również zawierać wersje opcjonalne. Producent zastrzega sobie prawo do zmiany specyfikacji i wyposażenia swoich produktów bez uprzedniego powiadomienia.

Note: For informational purposes only. Illustrations may show options. The manufacturer reserves the right to change the technical characteristics and specification of its products without notice.

Hinweis: Alle Angaben ohne Gewähr. Abbildungen können auch optionale Ausführungen zeigen. Der Hersteller behält sich das recht vor, die technischen Daten und Ausstattungen seiner Produkte ohne vorherige Ankündigung zu ändern.

Na www.simpledoor.pl zapraszamy na wirtualną wycieczkę po całej ofercie SIMPLE DOOR. Dowiedz się więcej o naszej gamie modeli, aktualnych broszurach i informacjach technicznych.

Visit www.simpledoor.pl to take a virtual tour of SIMPLE DOOR's entire product range. Find out more about our models, current brochures and technical information.

Auf www.simpledoor.pl laden wir Sie zu einem virtuellen Rundgang durch das gesamte SIMPLE DOOR Sortiment ein. Informieren Sie sich über unsere Modell-Vielfalt, aktuelle Prospekte und technische Informationen.

Copyright © Wszelkie prawa zastrzeżone / All rights reserved / Alle Rechte vorbehalten

